

FRONT END CYLINDER

TYPE : MF-RO

SERIE : Ø 165

CYL.TYPE

MF 165.4.5300 RO - D.1783

For Tipping Weight See Advices Below

Technical Characteristics

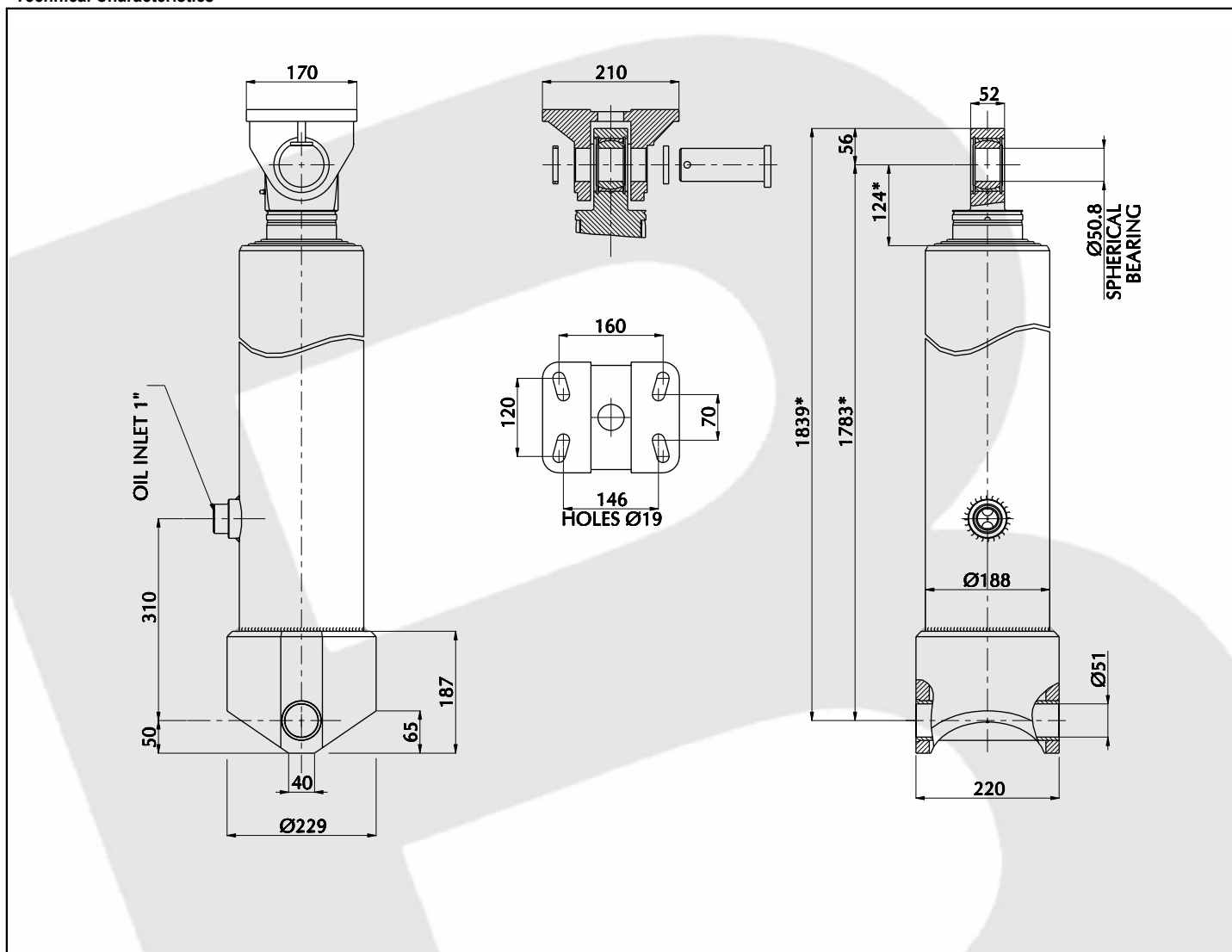

Cylinder stages

Ø Stage	Ø045	Ø060	Ø076	Ø092	Ø108	Ø069	Ø088	Ø107	Ø126	Ø145	Ø165	Ø167	Ø187	Ø210	Ø236	Ø265
Thrust at 200 Bar [Tons]	---	---	---	---	---	---	---	18.00	24.90	33.00	42.80	---	---	---	---	---
Stages of cylinder								●	●	●	●					

Specifications

Stages number		04
Cylinder Stroke [mm]		5300
Cylinder weight only [Kgs]		249
Working volume [Ltrs]		78.6
Max Working pressure [Bar]		200

Technical information

<input type="checkbox"/> Oil	: See oil specification sheet
<input type="checkbox"/> Tipping weight	: Net weight body + Payload
<input type="checkbox"/> Fitted centres [*]	: Closed centres plus 20 mm pull out

Brackets and Accessories

Lifting bracket	SSL#PFH	11.75 [Kgs] x 1 =

Recommendation

<input type="checkbox"/> This Binotto cylinder is designed as a lifting device only
<input type="checkbox"/> It must not be used as a structural member or be subject to side loads
<input type="checkbox"/> Pump flow in consultation with Binotto engineering department

Advices

All our cylinders are manufactured to suit the particular application in the differing world markets/climate. Should you require details of the exact lifting capacity of the cylinder that has been selected for your application/vehicle then please contact our technical department who will be only pleased to explain or advise.

BINOTTO SRL

BINOTTO IS CONSTANTLY ENGAGED IN IMPROVING ITS PRODUCTS AND THEREFORE RESERVES THE RIGHT TO MODIFY WITHOUT ANY NOTICE CHARACTERISTICS SHOWN

VIA DIVISIONE JULIA, 7/B - 36031 DUEVILLE [VI] ITALY • TEL. 0039.0444.593290 - FAX. 0039.0444.593357 • E-MAIL. INFO@BINOTTO.COM

Edit.: 04 • 2006
Rev.: 01 • 2006
Date: 01.09.2006

Pag.: MF-RO 165.4.5300_01