

PNEUMATIC CONTROL DEVICES

TYPE : SANDWICH

CONTROL DEVICES.TYPE

DPNC#

Sandwich controls with rear ports

Technical Characteristics

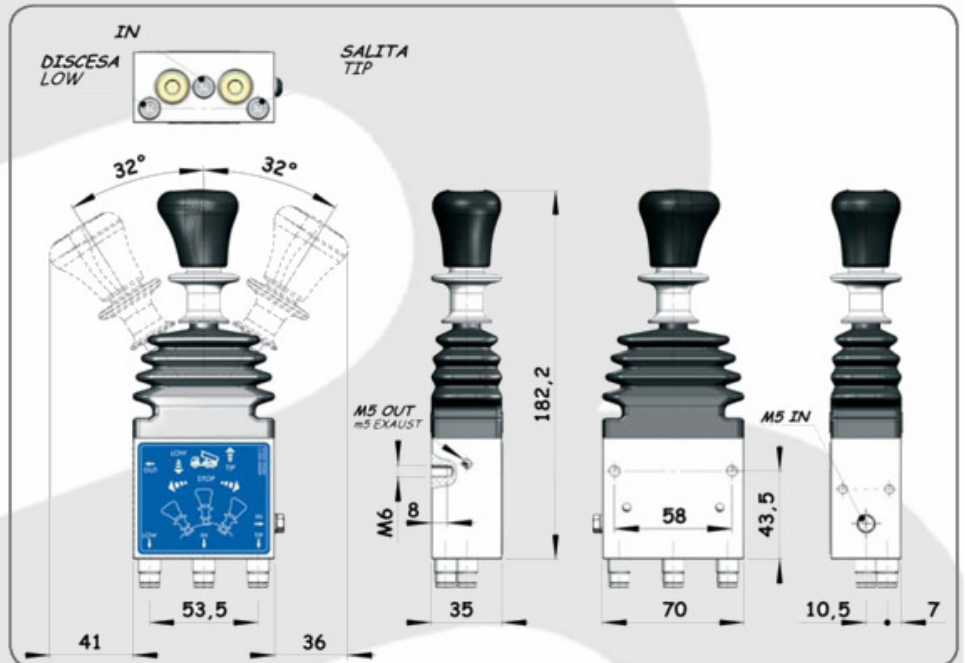

	Versioni disponibili Available versions	Proportional Lowering	Functional Diagram	Pressure		Temperature	
				Min. Bar	Max. Bar	Min. °C	Max. °C
Ritorno cloche Lever return	Automatic Automatic "CE"	DPNC#D00000		5	12	-30	+80
	Manuale Manual (con blocco salita/discesa) (with low and tip block)	DPNC#B00000					

BINOTTO SRL

BINOTTO IS CONSTANTLY ENGAGED IN IMPROVING ITS PRODUCTS AND THEREFORE RESERVES THE RIGHT TO MODIFY WITHOUT ANY NOTICE CHARACTERISTICS SHOWN

VIA DIVISIONE JULIA, 7/B - 36031 DUEVILLE [VI] ITALY • TEL. 0039.0444.593290 - FAX. 0039.0444.593357 • E-MAIL. INFO@BINOTTO.COM

Edit.: 04 • 2006

Rev.: 01 • 2006

Date: 01.04.2006

Pag.: DPNC#.001

PNEUMATIC CONTROL DEVICES

TYPE : SANDWICH

CONTROL DEVICES.TYPE

DPNC#

Sandwich controls with rear ports

Technical Characteristics



UTILIZZO 1
Deliver 1

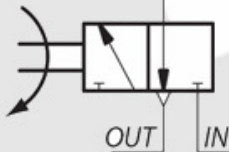

DPNC#0L0000

Deviatore pneumatico 2 vie 2 posizioni attacchi inferiori.
2 way & 2 position pneumatic controls with rear ports

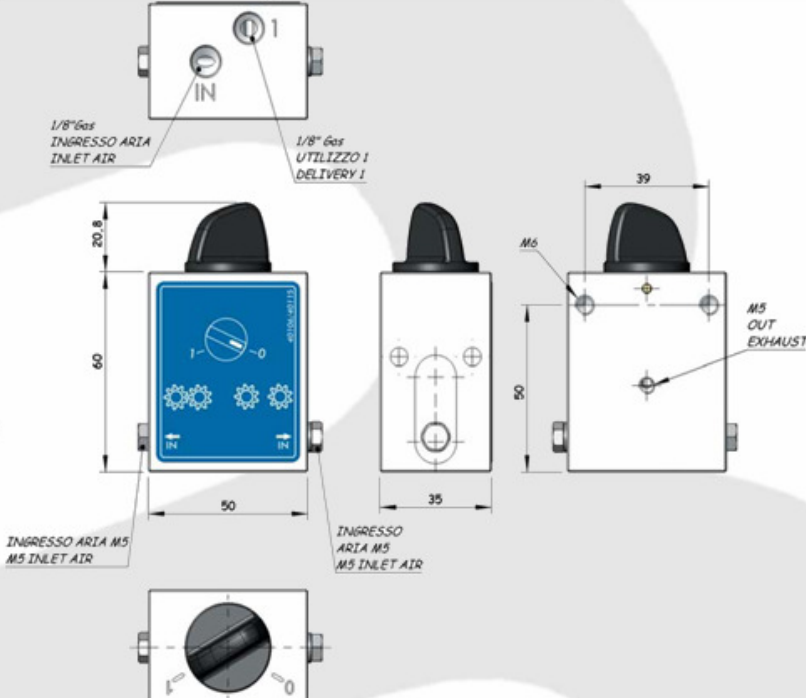

1/8" Gas INGRESSO ARIA INLET AIR

1/8" Gas UTILIZZO 1 DELIVERY 1

20.8

60

50

35

39

M5

M5 OUT EXHAUST

INGRESSO ARIA M5 M5 INLET AIR

INGRESSO ARIA M5 M5 INLET AIR



UTILIZZO 1
Deliver 1

UTILIZZO y
Deliver y

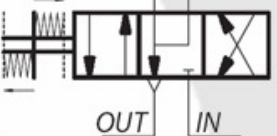

DPNC#0H0000

Deviatore pneumatico 3 vie 3 posizioni attacchi inferiori.
3 way & 3 position pneumatic controls with rear ports

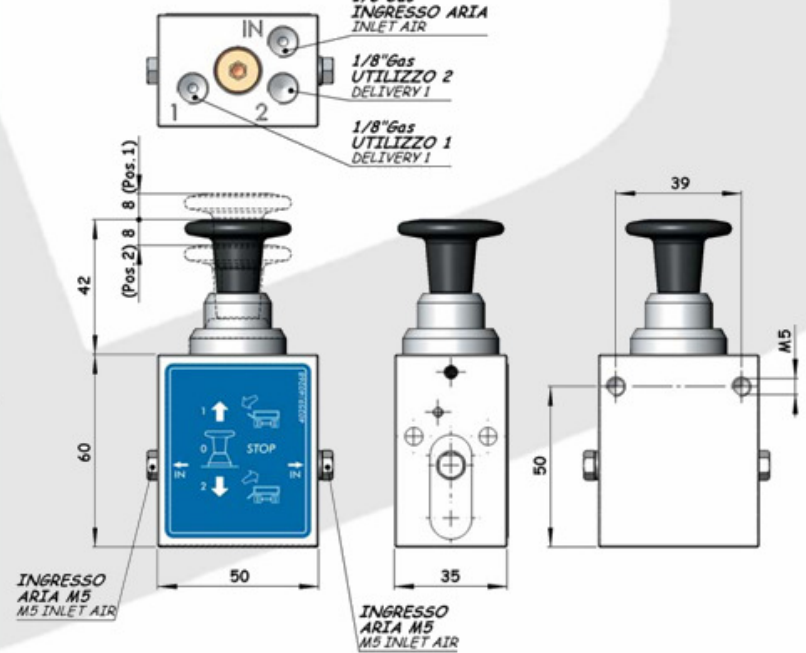

1/8" Gas INGRESSO ARIA INLET AIR

1/8" Gas UTILIZZO 2 DELIVERY 1

1/8" Gas UTILIZZO 1 DELIVERY 1

42

(Pos. 2) 8 & (Pos. 1)

60

50

35

39

M5

INGRESSO ARIA M5 M5 INLET AIR

INGRESSO ARIA M5 M5 INLET AIR

BINOTTO SRL

BINOTTO IS CONSTANTLY ENGAGED IN IMPROVING ITS PRODUCTS AND THEREFORE RESERVES THE RIGHT TO MODIFY WITHOUT ANY NOTICE CHARACTERISTICS SHOWN

VIA DIVISIONE JULIA, 7/B - 36031 DUEVILLE [VI] ITALY • TEL. 0039.0444.593290 - FAX. 0039.0444.593357 • E-MAIL. INFO@BINOTTO.COM

Edit.: 04 • 2006

Rev.: 01 • 2006

Date: 01.04.2006

Pag.: DPNC#.002